

WATERMARK

BROOKLYN, NEW YORK

SH-RH070

Pan Rain Shower Head, 6" dia.



- Flow Rate: 1.75 GPM at 60 psi
- Self-Cleaning Silicone Jets
- Swivel Range of Motion: 20-25°
- Professional Installation Required.

Available in all finishes shown on the [Watermark Designs website](#)

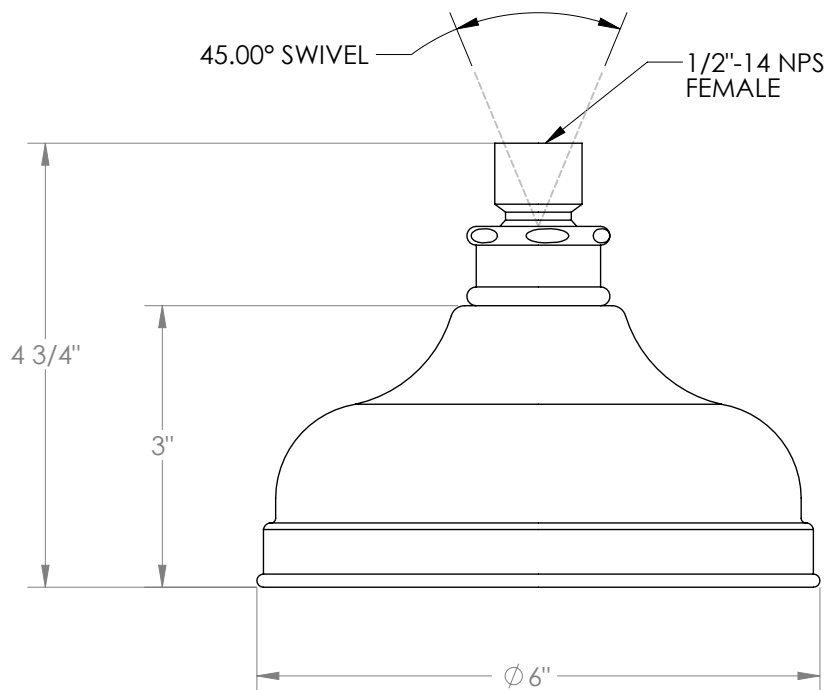

Meets the applicable requirements of ASME A112.18.1-2005/CSA B125.1-05, entitled "Plumbing Supply Fittings".

Watermark Designs reserves the right to make revisions without notice to produce specifications. All product dimensions are nominal.

05/2022

350 Dewitt Ave. Brooklyn, NY 11207 USA | T: 1 718 257 2800 | F: 1 718 257 2144 | customerservice@watermark-designs.com