

321-8.3STP-

Floor Standing Bath Set with Hand Shower and Shut-Off Valves

Hand Shower Flow Rate: 1.75 GPM

Note: Some building codes may require remote pressure balance valves for anti-scald

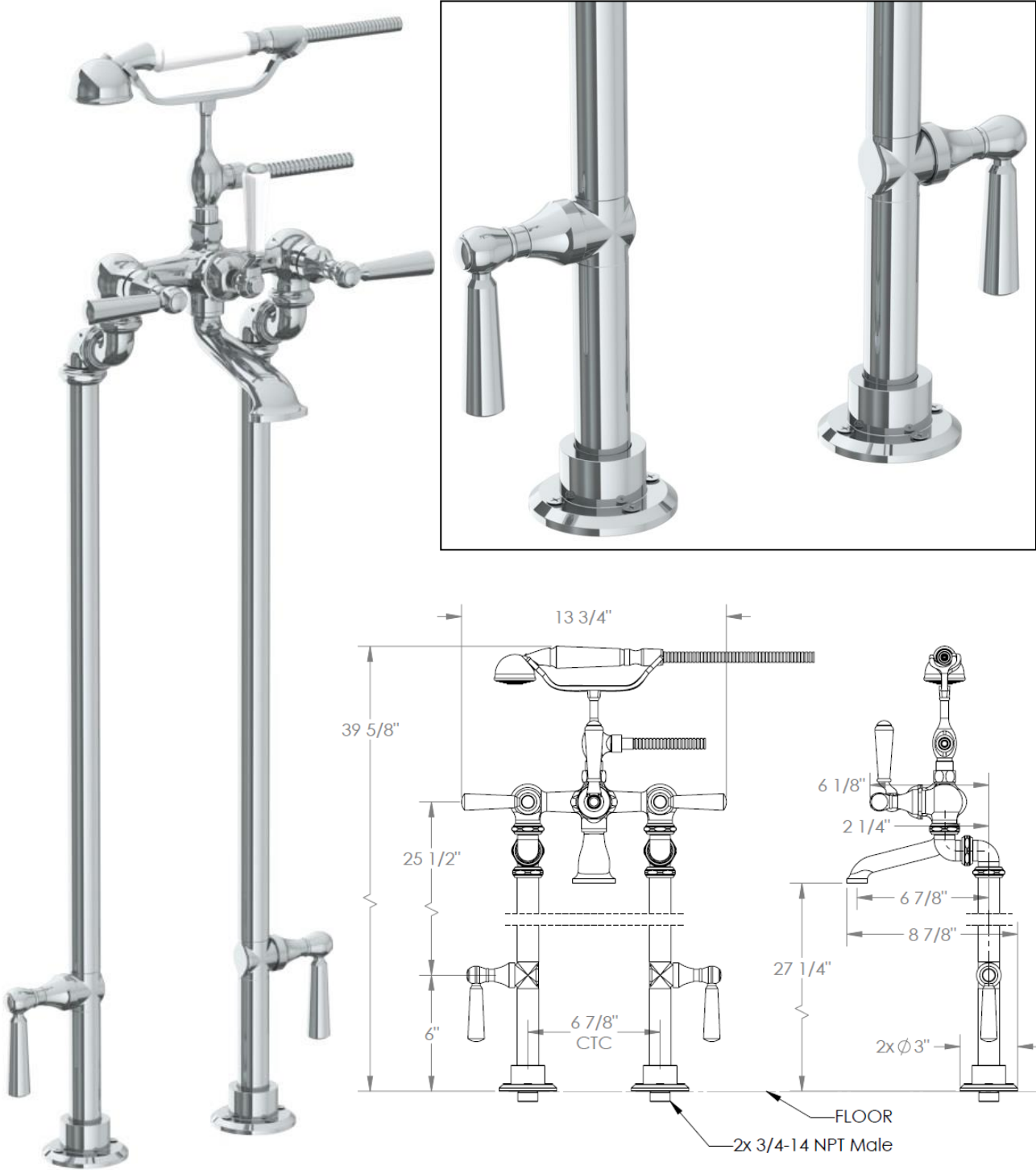

Meets the applicable requirements of ASME A112.18.1-2005/CSA B125.1-05, entitled "Plumbing Supply Fittings"

WATERMARK DESIGNS

6/29/2020

HANDLE TRIM OPTIONS

S1 - PRESTON

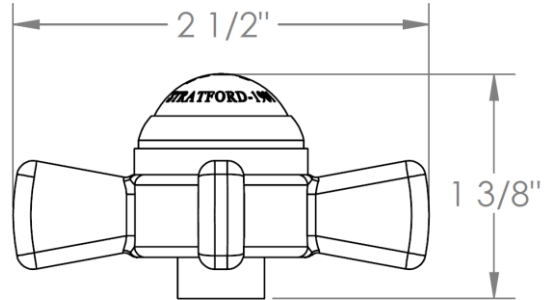

S2 - WALTHAM

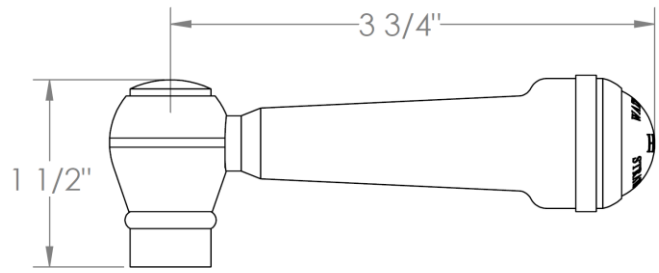
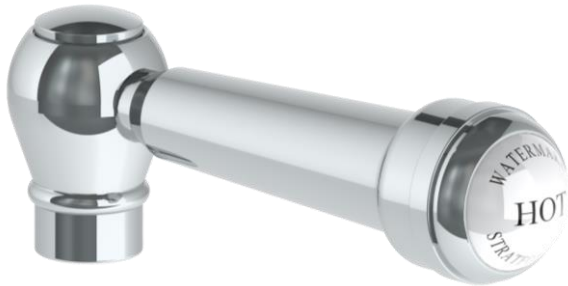

SWA - DARIEN

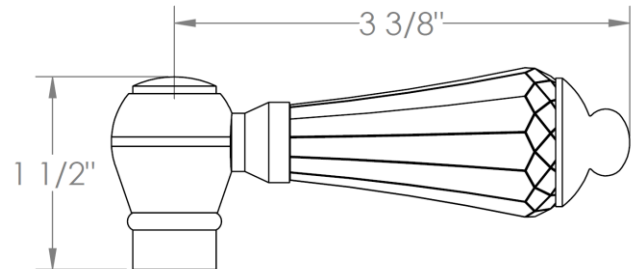

V - WALES

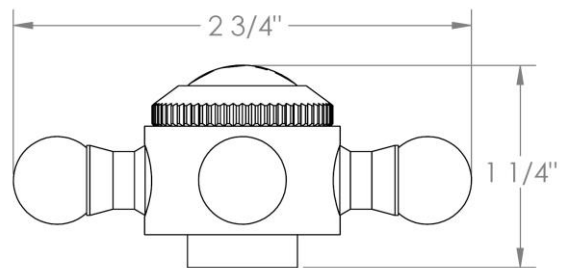

S1A – NOTTINGHAM

