

VIGO Linear Shower Drain

VG07002

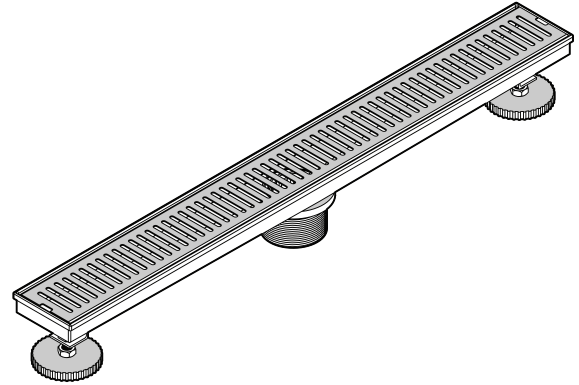

MEASUREMENTS (ASSEMBLED)

24"L x 2 3/4"W x 2 1/2"H

MATERIAL

304-series stainless steel

PRODUCT FEATURES





- FinishPlated technology ensures the brushed nickel finish is consistent throughout the entire drain.
- EZInstall makes linear drain installation seamless with all parts, hardware, and guide.
- The shower drain is easy to level with concrete floors and bathroom floors.
- 304-series stainless steel makes the shower floor drain strong and rust-resistant.
- Elegantly conceals the shower drain and provides a clean look for walk-in showers.
- Slopped channel helps maintain a self-cleansing flow and complete water drainage.
- Can be installed in multiple types of shower layouts with standard shower plumbing fixtures.

CODES / STANDARDS



- cUPC Certified
- All VIGO Bathroom Hardware has a 1 Year Limited Warranty

AVAILABLE FINISHES

Color**	Code	Description
	CH	Chrome
	BN	Brushed Nickel
	MB	Matte Black
	MG	Matte Brushed Gold

* See website for detailed warranty information.

**Color swatches intended for reference only.

SPECIFICATIONS

VIGO Linear Shower Drain

VG07002

