

SPECIFICATIONS

WINEMAKER 30" VANITY

Winemaker Series

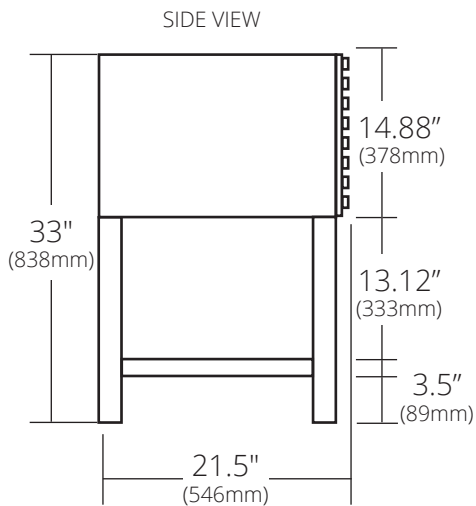
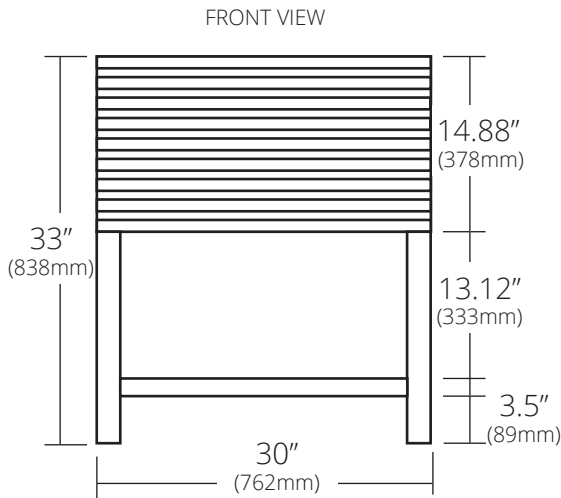

VNM301 - Cask Oak (shown)
VNM308 - Charred Oak

PRODUCT DETAILS

- 30"w x 21.5"d x 33"h (762mm x 546mm x 838mm)
- Reclaimed wine-infused oak staves
- Black steel legs
- Full-extension drawer with soft-close slides and U-channel for P-Trap
- Low VOC water-resistant finish

INSTALLATION

- Freestanding vanity base

COORDINATING PRODUCTS

- Winemaker Mirror
- Any Native Trails vanity top
- Combine with any Native Trails sink less than 7" deep

IMPORTANT

Due to the handcrafted nature of this product, it will vary in finish, texture, and other details. Dimensions may vary up to 1/4" (6mm).