

Following these mounting instructions with the hardware included will be more than sufficient to support pedestal installation.

Included Sink Installation Hardware

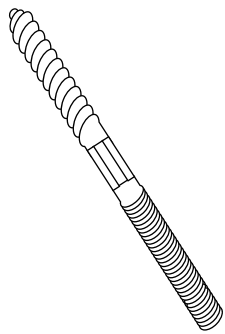

x2 Hanger Bolts (8mm)

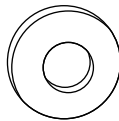

x2 Washer

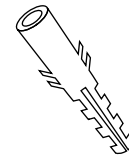

x2 Wall Anchor

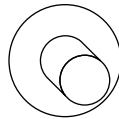

x2 Insulation Sleeve

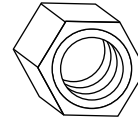

x2 Nuts

Tools You May Need

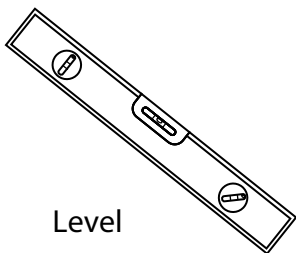

Level

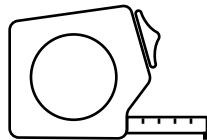

Tape Measure

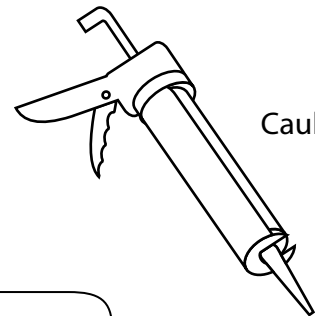

Caulk

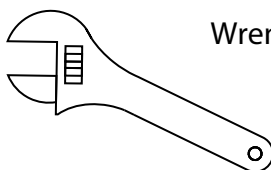

Wrench

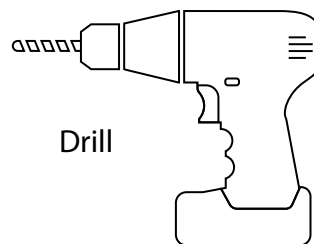

Drill

1. Prepare Location

Locate studs in the wall. If the studs do not line up with the holes in the back of the sink, be sure to add sufficient wall supports behind the finished wall.

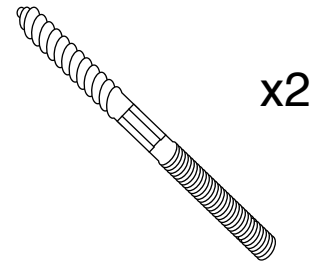
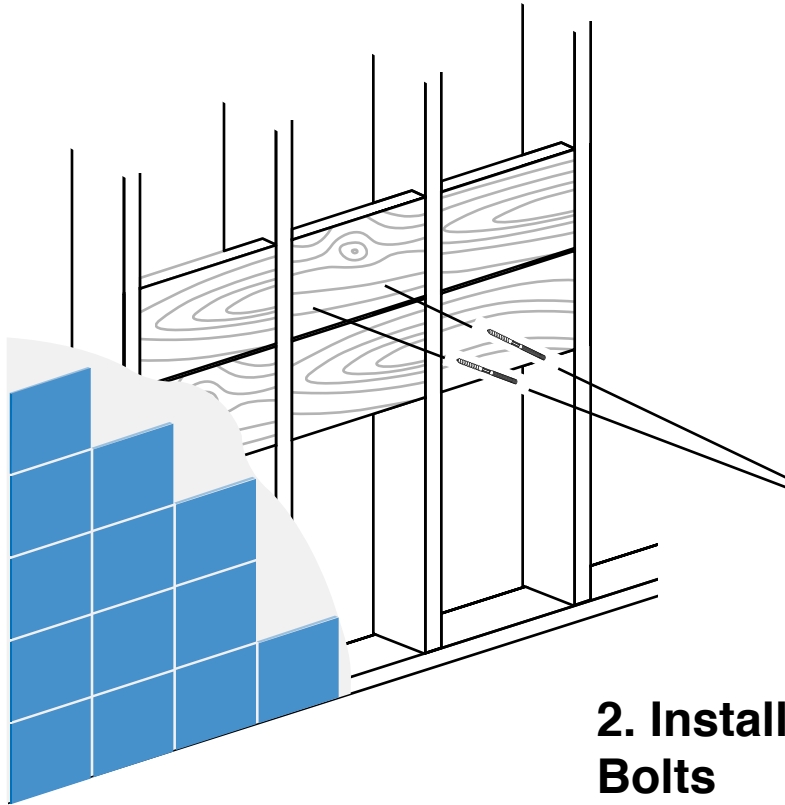

2. Install Hanger Bolts

Measure the distance between mounting holes in the back of the sink. Measure the total distance from pedestal and sink mounting holes. Drill pilot holes in wood and screw in hanger bolts. Check position with a level.

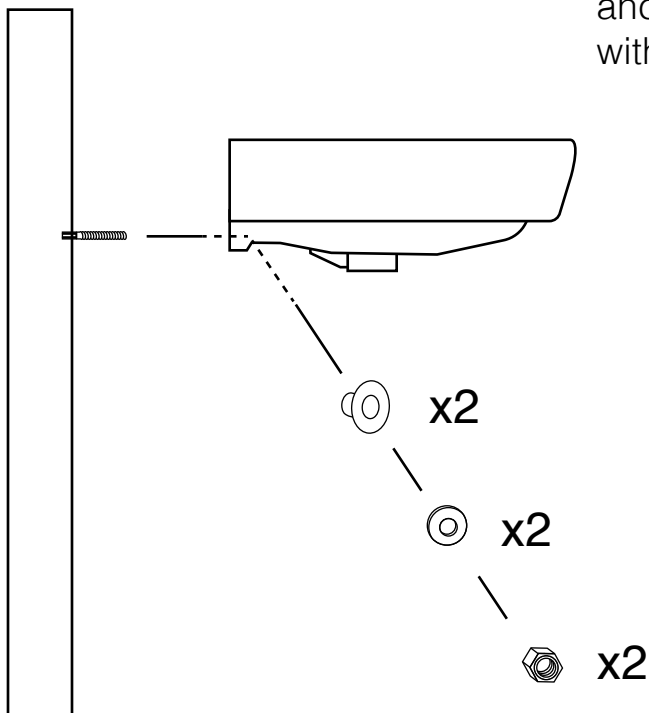

3. Secure Sink With Washers and Nuts

Thread the sink on to the two hanger bolts. Secure the sink with insulation sleeves, washers and nuts. Be careful not to over tighten the bolts. Overtightening can cause the sink to chip and crack.

4. Install Sink Accessories

Complete your sink by adding the preferred plumbing accessories, such as the faucet, click clack drain, p-trap and angle valves to your sink.

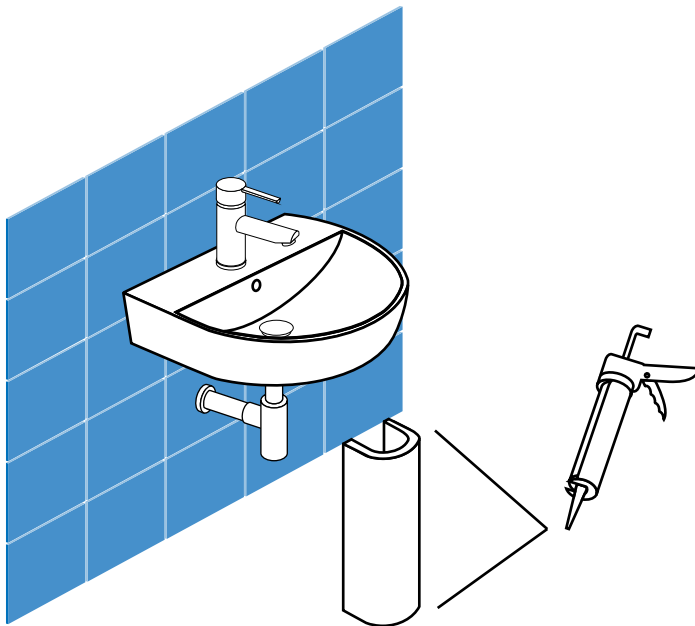
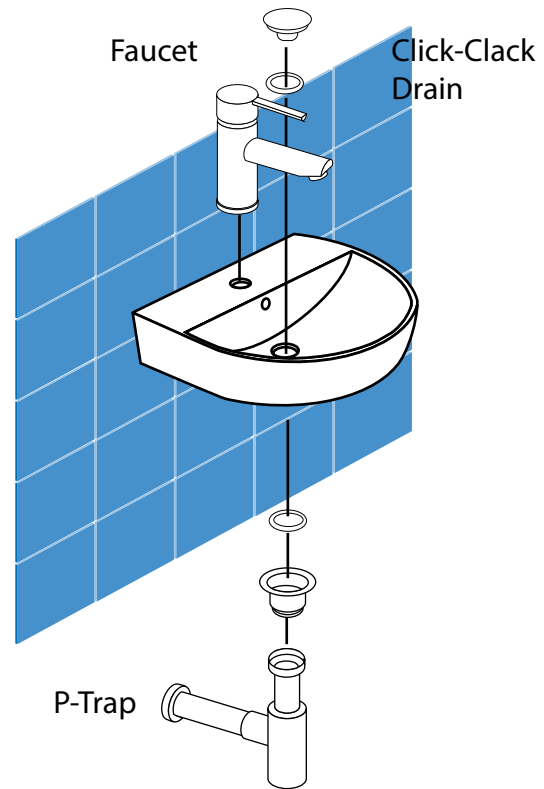

5. Mount Pedestal Under Sink

Position the pedestal under the sink. Mount the pedestal to the floor and sink with adhesive.

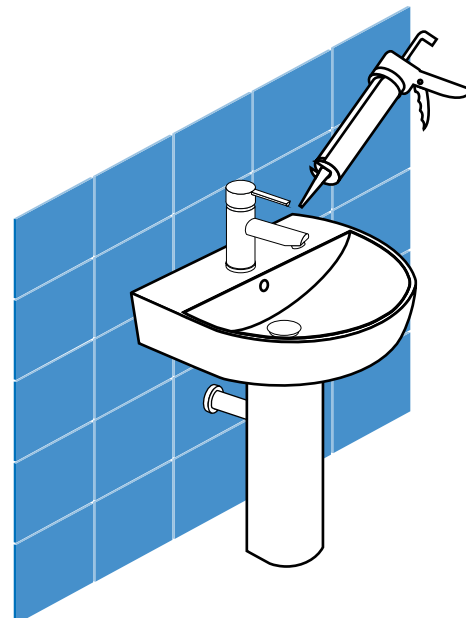

6. Install Caulk

Finish the sink installation with a bead of caulk between the sink and wall.