

# Model 5231 Essence 4260

Swirl-way® Oval MicroDerm™ Therapeutic Bath



## MicroDerm™ Therapeutic Bath Features

- 60" x 41-1/2" x 24" oval bathtub
- MicroDerm™ microbubble technology
- Sculpted armrests and lumbar backrest
- Two pillows
- Mansfield® Limited Ten Year Warranty
- Available in standard colors (white, bone, biscuit and almond) and premium colors\* (British khaki, black and ice gray)

\*additional charge will apply





Model 5231

## Options

### Cable Drain

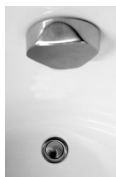
### Lift and Turn Drain

Model #	Description		Model #	Description	
SW1319	Standard Colors		PF1320	Polished Chrome	
SW1320	Polished Chrome		PF1321	Everbrass (PVD)	
SW1321	Everbrass (PVD)		PF1322	Brushed Nickel	
SW1322	Brushed Nickel		PF1323	Oil Rubbed Bronze	
SW1323	Oil Rubbed Bronze		SWA100	Rainbow Pillow	

### Trim

Model #	Description
-	Color-match trim included for standard colors
MD1335	Polished Chrome (for premium colors)



**MADE IN USA**

# Model 5231 Essence 4260

Swirl-way® Oval MicroDerm™ Therapeutic Bath



## Specifications

Model #	Description
5231	60" x 41-1/2" x 24" Oval

Specification	Description	Specification	Description
Material	Acrylic, fiberglass reinforced	Number of Jets	2
Construction	Self-contained, pre-plumbed bath system, mounted on a pre-leveled base	Water Capacity	60 gal. (min.) 75 gal. (max.)
Pump Motor	120V, 10 Amp, 60 Hz Thermally protected	Floor Loading Weight	47 lbs. / sq. ft. (229 kg /m <sup>2</sup> )
Electrical Requirements	120V, 20 Amp, GFCI protected circuits	Shipping Weight	170 lbs.
On/Off Control	Single Button electronic control, 20-minute time cycle	Warranty	Limited Ten Year

## Technical Information

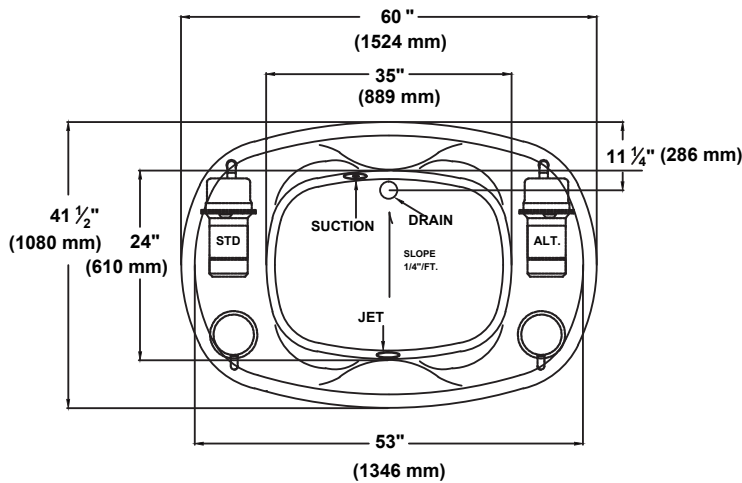

Pump locations shown for clarity.  
STD - Standard location ALT - Alternate location

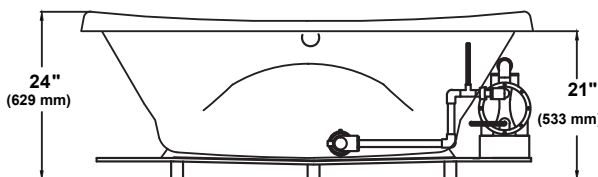

Rough-in measurements may vary 1/4" (+/-)

NO APRON AVAILABLE ON THIS MODEL

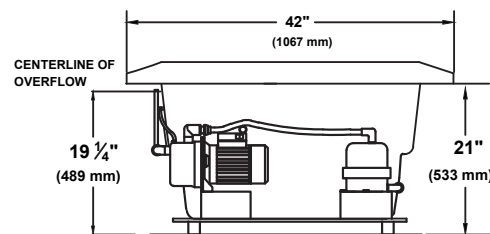
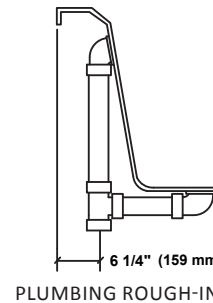

**Installer Note:** Due to the freeform shape of this tub, it is recommended that the tub be on the jobsite before making the final cut out for drop-in installation.

These dimensions are nominal and subject to change without notice.

When tested for compliance to the requirements of ASME A112.19.7M for "Whirlpool Bath Appliances" and ANSI Z124.1.2M "American National Standard for Plastic Bathtub and Shower Units", the tested units are found to comply and are acceptable for listing under IAPMO R & T.

Certified for permanent connection only.



**MADE IN USA**