

# 384-3386 SUMMIT® DUAL FLUSH

**MANSFIELD®**

Elongated Front, SmartHeight™, Vitreous China, Two-Piece Toilet

## FEATURES

- Dual flush technology with 3" flush tower
- 1.1 Gpf / 1.6 Gpf (4.0 Lpf / 6.0 Lpf)
- Elongated front, SmartHeight™ bowl
- SmartFasten™ 3-bolt tank-to-bowl connection
- PuraClean® easy-to-clean glaze
- Pilot operated anti-siphon fill valve
- 12" rough-in
- Model 33 chrome-plated, push button actuator
- 2" glazed trapway
- The Mansfield® limited lifetime warranty
- Available in White, Biscuit and Bone



**MODEL 384-3386**

Toilet seat not included

Available as CTK



ELONGATED





SMARTHEIGHT ADA



CTK

## COMPONENTS

MODEL #	DESCRIPTION	CODES/STANDARDS
384-3386	Elongated front, SmartHeight™, two-piece dual flush toilet. Less toilet seat and supply. Specify color.	  
384	Elongated front, SmartHeight™ toilet bowl only. Less supply. Specify color.	
3386	Tank and cover only, with chrome-plated, push button actuator. Less supply. Specify color.	
TANK TRIM & REPLACEMENT PARTS		
33	Chrome-plated push button actuator	
2206	Pilot operated fill valve	
308	Dual flush tower	
3386-LID	Tank lid	





# 384-3386 SUMMIT® DUAL FLUSH



Elongated Front, SmartHeight™, Vitreous China, Two-Piece Toilet

## SPECIFICATIONS

MODEL #	DESCRIPTION	CODES/STANDARDS
384-3386	Elongated front, SmartHeight™ (1.1 gpf/1.6 lpf) two-piece toilet	  

MATERIAL	Vitreous China
WATER PRESSURE RANGE	20 to 80 PSI
FLUSH SYSTEM	Dual flush with 3' flush tower
WATER USAGE	1.1 gpf / 1.6 lpf
WATER SURFACE AREA	9' X 10'
ROUGH-IN	12'
MAP RATING	800 grams

TRAP DIAMETER	2'
TRAP SEAL	2-3/8'
SHIPPING WEIGHT	Model 384 - 54 lbs. (24.4 kg) Model 3386 - 38 lbs. (17.2 kg)
WARRANTY	Vitreous China - Limited Lifetime Tank Trim - Limited One Year

## TECHNICAL INFORMATION

**Note:** these dimensions are nominal and subject to change without notice.

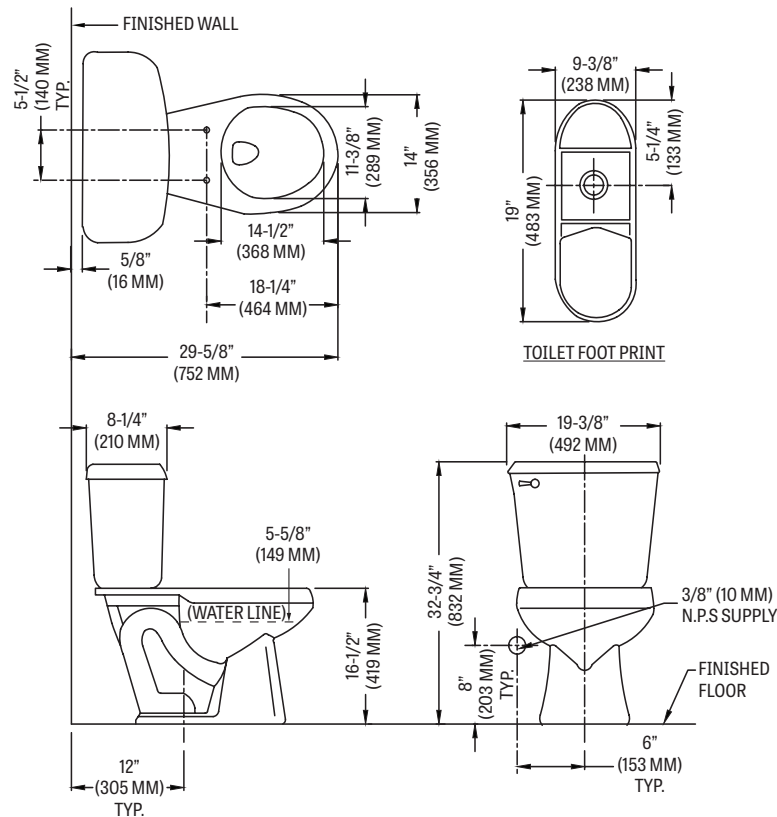

Fixture performance and specifications meet or exceed ASME A112.19.2-2013/CSA B45.1-13 standards, and other state and local codes.

