

Features

- 18-inch minimum base cabinet.
- Single bowl.
- 9-1/2-inch depth.
- No faucet holes.
- Includes K-5658 bottom sink rack.
- Includes cutout templates and installation clips.

Material

- KOHLER Neoroc® composite is durable and built to withstand day-to-day cleaning tasks.
- Matte finish offers rich, dimensional color.
- Solid color throughout the sink.
- Heat resistant up to 750 degrees F.
- Scratch, stain, chip, and thermal-shock resistant.

Installation

- Under-mount
- Easy to install in a one-person, single-day project.

Recommended Products/Accessories

K-9000 P-Trap
K-8801 Sink Strainer
K-8799 Sink Strainer

Included Components

Additional Components:
K-5658



ADA

Codes/Standards







CSA B45.5/IAPMO Z124
ADA
ICC/ANSI A117.1

KOHLER® Neoroc® Sinks Lifetime Limited Warranty

See website for detailed warranty information.

Available Colors/Finishes

Color tiles intended for reference only.

| Color | Code | Description |
|--|------|----------------|
|  | CM6 | Matte White |
|  | CM7 | Matte Graphite |
|  | CM5 | Matte Beige |
|  | CM1 | Matte Black |
|  | CM2 | Matte Brown |
|  | CM3 | Matte Toupe |
|  | CM4 | Matte Grey |

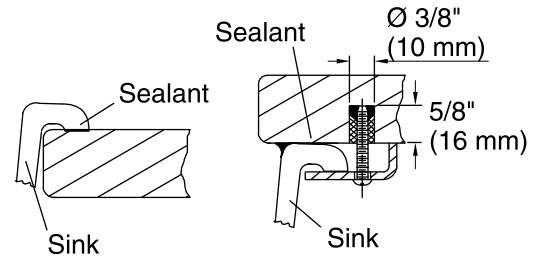
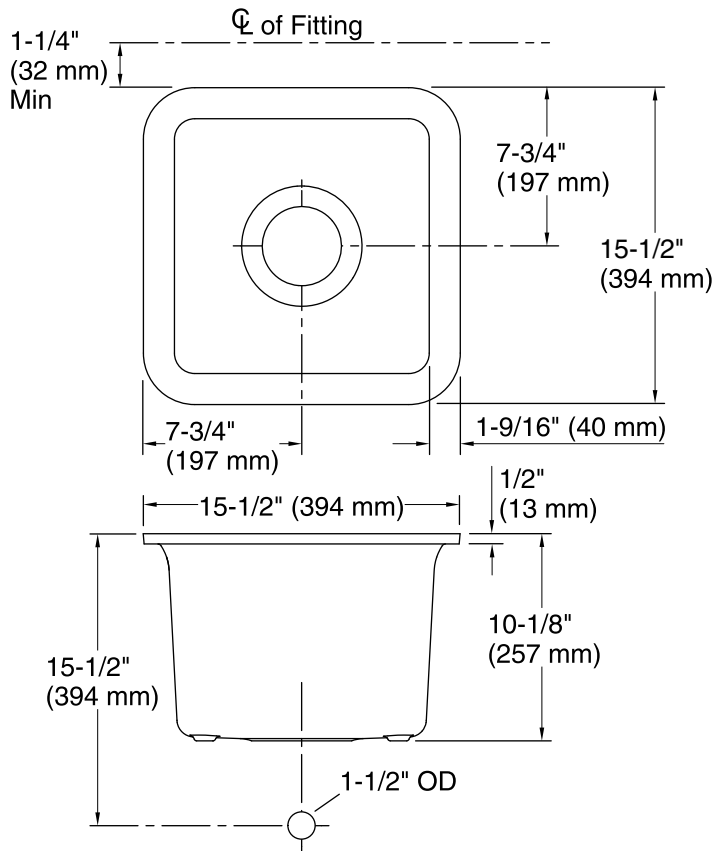

Top-Mount Installation

Under-Mount Installation

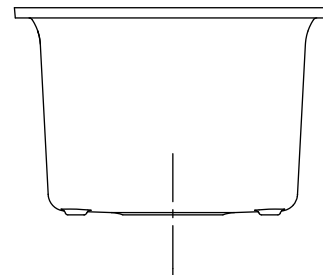

Technical Information

All product dimensions are nominal.

| | |
|---------------|--|
| Installation: | Under-mount |
| Bowl area: | Length: 13-9/16" (344 mm) Width: 13-9/16" (344 mm) Bowl depth: 9-1/2" (241 mm) Water depth: 9-1/2" (241 mm) |
| Template: | 1257826-7, required, included |

Notes

Install this product according to the installation instructions.

ADA compliant when installed to the specific requirements of these regulations.

ADA permits a parallel approach to wet bars.