

Features

- Safeguard® slip-resistant finish for added safety.
- Single threshold for tile-in or drop-in installation.
- KOHLER® enameled cast iron.
- Center drain.
- Coordinates with other products in the Purist collection.

Recommended Products/Accessories

- K-1733 9 kW Steam Generator
- K-9132 Shower Drain
- K-705704-L Frameless Pivot Shower Door
- K-705710-L Frameless Pivot Shower Door
- K-705716-L Frameless Pivot Shower Door
- K-705722-L Frameless Pivot Shower Door
- K-705728-L Frameless Pivot Shower Door
- K-705740-L Frameless Pivot Shower Door
- K-5526 7 kW Steam Generator
- K-5557 steam generator control kit



Codes/Standards















ASME A112.19.1/CSA B45.2
ASTM F462

KOHLER® Enameled Cast Iron Bath and Shower Base Lifetime Limited Warranty

See website for detailed warranty information.

Available Colors/Finishes

Color tiles intended for reference only.

Color	Code	Description
	0	White
	FF	Sea Salt™
	96	Biscuit
	47	Almond
	FD	Cane Sugar™
	NY	Dune
	95	Ice™ Grey
	G9	Sandbar
	33	Mexican Sand™
	K4	Cashmere
	FT	Basalt
	58	Thunder™ Grey
	KA	Black 'n Tan
	7	Black Black™

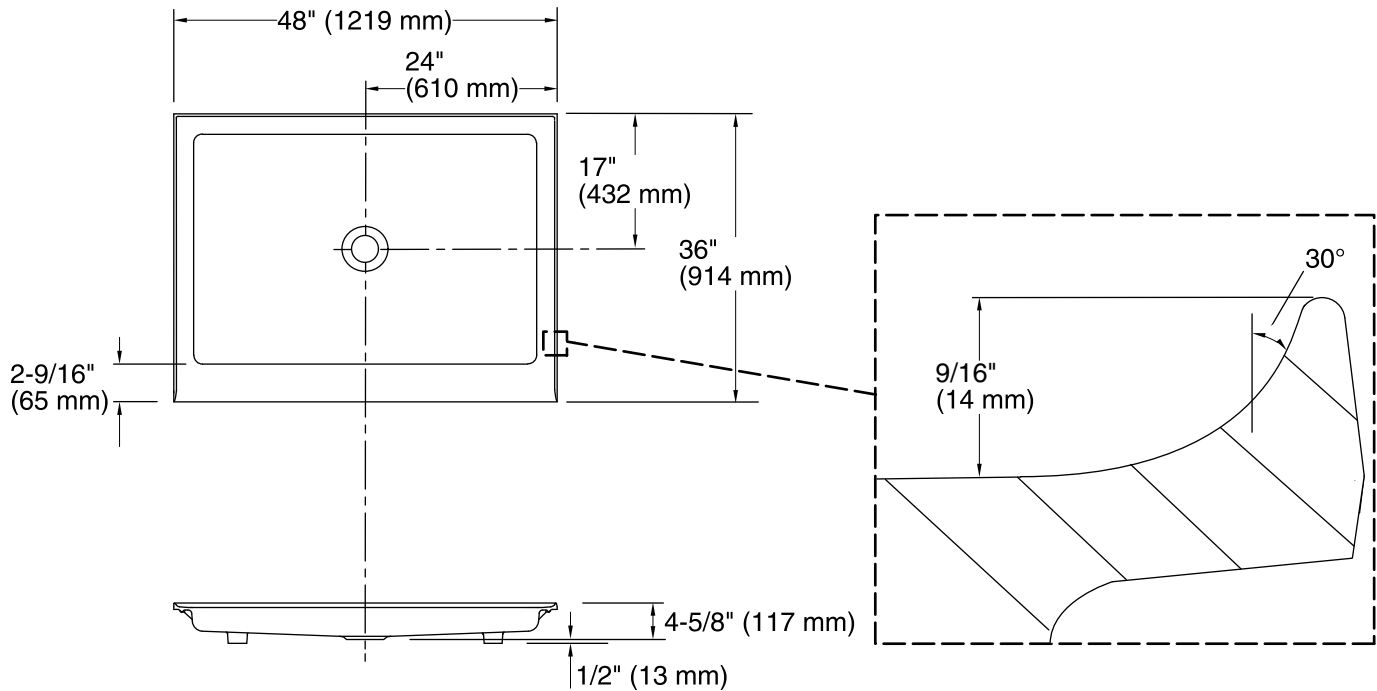

Technical Information

All product dimensions are nominal.

Installation:	Drop-in
Drain location:	Center
Weight:	175 lbs (79.4 kg)
Minimum floor load:	20 lbs/ft ² (97.6 kg/m ²)

Notes

Measure your actual product for rough-in details. Install this product according to the installation instructions.

The dimensions are applicable for this product only and should not be used to fabricate substitute bases for shower enclosures.

KOHLER steam generator/control kit is designed for use with this product. Kohler Co. shall not be responsible for problems encountered due to the installation and use of other manufacturer's steam generators.