

## Features

- Solid brass construction ensures durability and reliability.
- KOHLER finishes resist corrosion and tarnishing.
- Without overflow.
- For use in non-overflow applications.



## Codes/Standards













ASME A112.18.2/CSA B125.2

## KOHLER® One-Year Limited Warranty

See website for detailed warranty information.

## Available Colors/Finishes

*Color tiles intended for reference only.*

Color	Code	Description
	CP	Polished Chrome
	SN	Vibrant® Polished Nickel
	AF	Vibrant® French Gold
	PB	Vibrant® Polished Brass
	PGD	Vibrant® Moderne Polished Gold
	G	Brushed Chrome
	BN	Vibrant® Brushed Nickel
	VS	Vibrant® Stainless
	BV	Vibrant® Brushed Bronze
	2BZ	Oil-Rubbed Bronze
	BL	Matte Black
	TT	Titanium
	VNT	Vintage Nickel

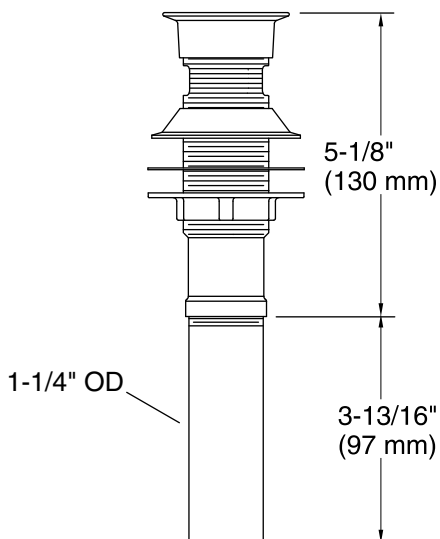
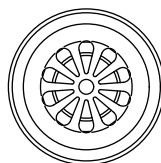

**Technical Information**

All product dimensions are nominal.

**Notes**

Install this product according to the installation guide.