



Iron/Tones®

24-1/4" top-/undermount single-bowl bar sink
K-6585

Features

- 27" (686 mm) minimum base cabinet width
- Single bowl
- 7-1/2" (191 mm) depth

Material

- KOHLER® enameled cast iron

Installation

- Top-mount or undermount

Recommended Products/Accessories

- K-3192 Sink rack for Iron/Tones® kitchen sinks
- K-5184 Stainless steel sink rack, 12-7/8" x 14-11/16"
- K-8801 Sink drain and strainer with tailpiece
- K-8799 Sink drain and strainer basket
- K-23726 Drain treatment
- K-23725 Cast iron cleaner

Optional Products/Accessories

- K-3277 Sink basket for Undertone® and Iron/Tones® sinks
- K-3294 Hardwood cutting board for kitchen sinks
- K-11352 Disposal Flange with Stopper
- K-9000 P-Trap

Included Components

- 1193643 Basin clamps



Codes/Standards











ASME A112.19.1/CSA B45.2

KOHLER® Enameled Cast Iron Kitchen and Bathroom Sink Lifetime Limited Warranty

See website for detailed warranty information.

Available Colors/Finishes

Color tiles intended for reference only.

Color	Code	Description
	0	White
	FF	Sea Salt™
	96	Biscuit
	NY	Dune
	95	Ice™ Grey
	58	Thunder™ Grey
	7	Black Black™
	TRF	Truffle
	DGB	Indigo Blue
	17	Teal

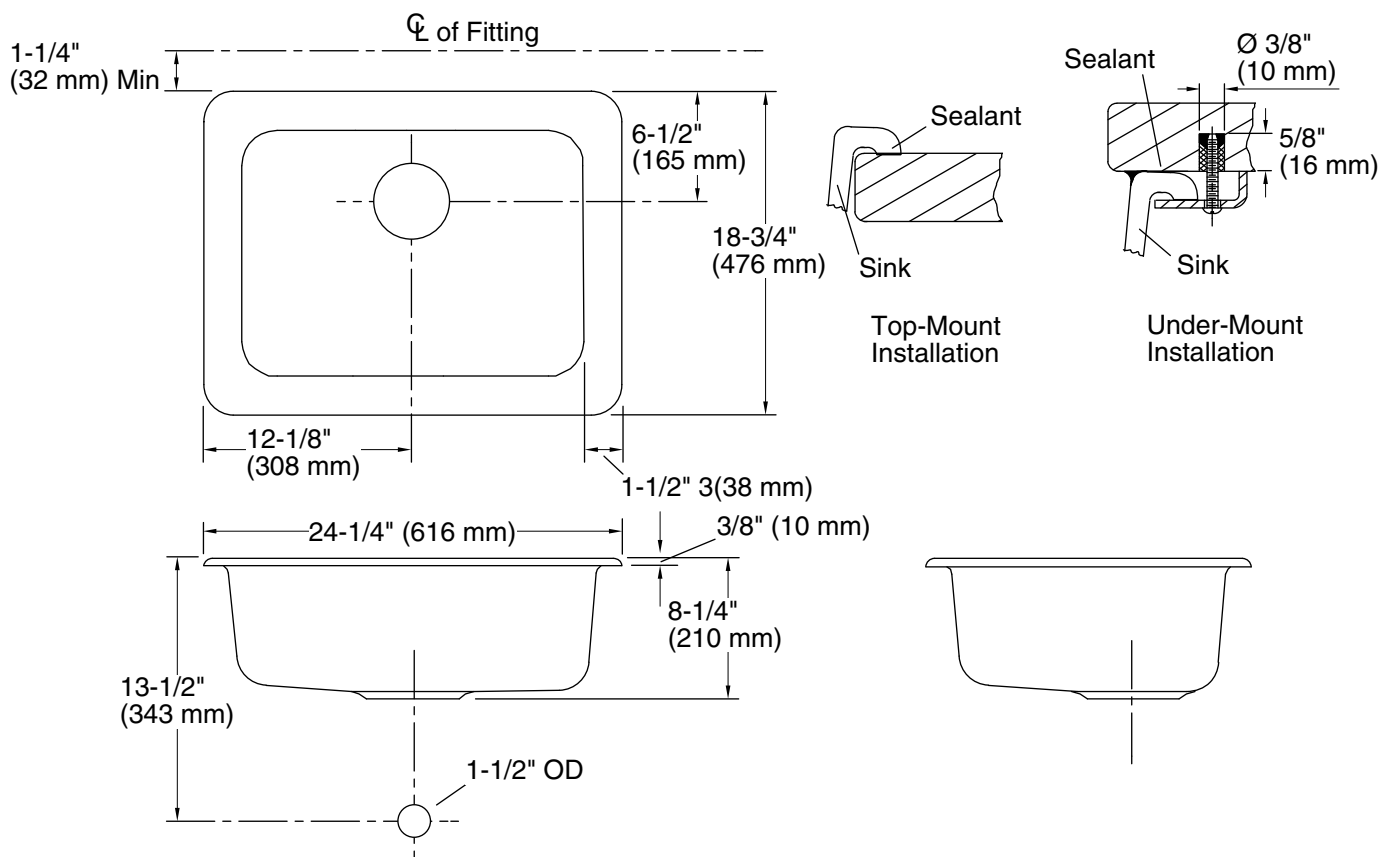

Technical Information

All product dimensions are nominal.

Bowl configuration:	Single
Min. base cabinet width:	27" (686 mm)
Bowl area:	Length: 21" (533 mm) Width: 16" (406 mm) Bowl depth: 7-1/2" (191 mm)
Drain hole:	3-7/8" (98 mm)
Template:	114333-7, required, included

Notes

Install this product according to the installation instructions.

Supplied bowl clamp assemblies require 1" (25 mm) minimum countertop thickness. Installer must supply hardware for thinner countertops.

For multiple bowl under-mount installations, a minimum distance of 3-3/8" (86 mm) is required between bowls. Countertop supplier to determine required support.